

Brickcom

Easy Installation Guide

Megapixel Day & Night
Outdoor Bullet Network Camera









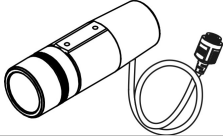

Outdoor Bullet V2 Series

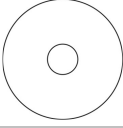
OB-100Ap/ WOB-100Ap/ GOB-100Ap

OB-130Np/ WOB-130Np/ GOB-130Np

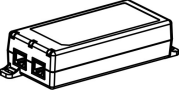
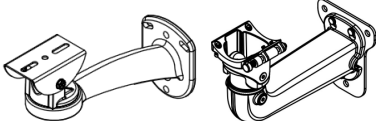
English

Step 1. Check Package Contents

<p>a. Network Camera (OB-Series V2)</p> 	<p>b. Shielding Cover</p> 
<p>c. Screw bag</p> 	<p>d. Product CD</p> 
<p>e. Warranty Card / Easy Installation Guide</p> 	<p>f. 2 Water Proof Connectors</p> 
<p>g. Dry Bag</p> 	<p>h. High Power POE (Optional)</p> 
<p>i. Bracket (Optional)</p> 	<p>j. Bracket Assembly Plate (Optional)</p> 
<p>k. Wi-Fi DualBand Antenna package(Optional)</p> 	<p>l. 3G Antenna package (Optional)</p> 

Step 2. Hardware Installation



WARNING - Do not mount the camera on a soft material. The camera may fall and be damaged.



This document is for easy installation purpose only; please refer to the user manual for more details.

I. Micro-SD/SDHC Card and 3G SIM Card Installation

- 1) Remove the Lens cover from the Bullet Camera.

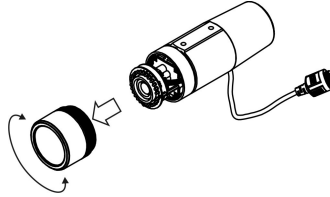

- 2) Inset the Micro-SD/SDHC card and 3G SIM card(+) into their respective slots.

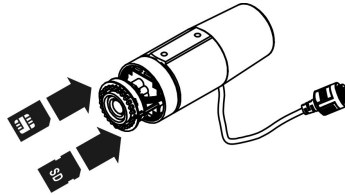

- 3) Place a dry bag onto the camera device.

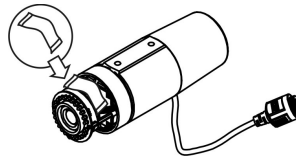

- 4) Reattach the Lens cover and secure the cover to the top of the camera device using two screws.

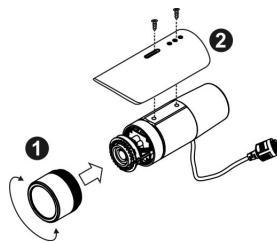

3

II. Wall Installation Using the Optional Bracket

- 1) Using the Bracket plate as a guide, drill three holes into the wall and hammer the supplied plastic anchors into the three holes. Use a screwdriver and the supplied screws to secure the plate to the wall.

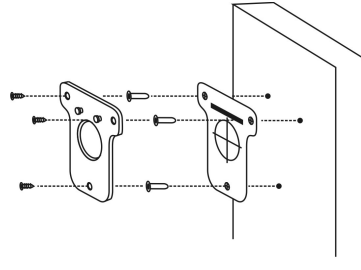

- 2) Attach the Bracket Assembly Plate to the bottom of the camera using two screws.

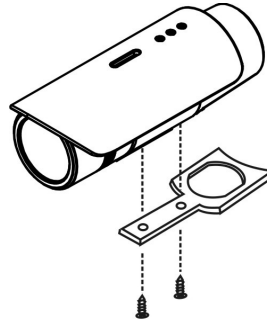

- 3) (1) Use the two supplied screws to secure the bracket to the side of the camera. (2) Push back the spring on the mortise lock and hook the camera and attached bracket onto the groove of the wall mount bracket as shown in the diagram.

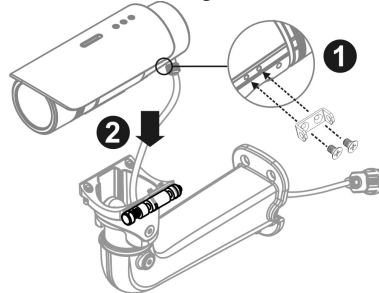

- 4) Connect (1) the POE cable; (2) DIDO, Audio In/Out, RS485 cable; and (3) Antenna cable with the camera. Refer to step 3 for more details installation information.

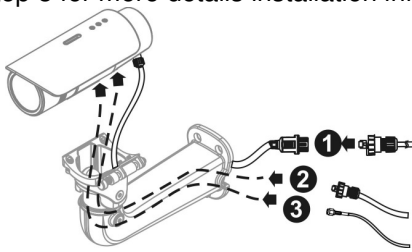

- 5) Secure the two screws on the wall mount bracket.

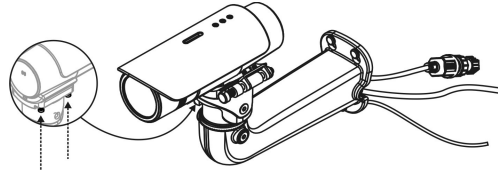

- 6) Place the wall mount bracket on the plate and attach it using the supplied screws. Adjust the angle of the wall mount bracket towards the area to be monitored.

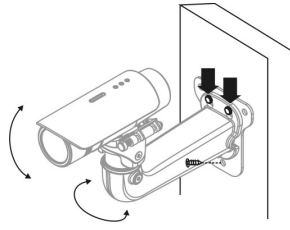

III. DIDO, Audio In/Out, RS485, and Antenna Connection

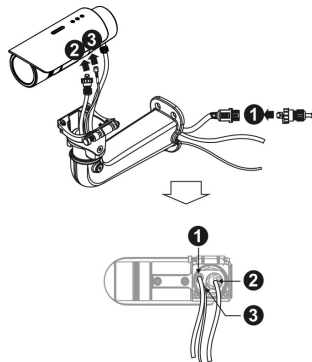

A. WiFi or 3G Antenna Extension Cable Connection

Pass the Antenna extension cable (1) through and bracket and connect it to the Antenna connector (2) at the bottom of the camera.

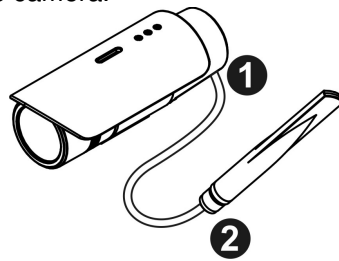

B. Water Proof Connector

Refer to the installation guide included in the package when installing the Water Proof connector.

- 1) Insert the stripped cable through the sealing nut and the housing. Clamp the cable with an RJ45 plug.
- 2) Push the RJ45 plug into the housing and secure the sealing nut tightly.
- 3) Attach the gasket to the front of the housing.
- 4) Connect the Ethernet cable to the RJ45 cable.
- 5) Secure the connectors tightly.

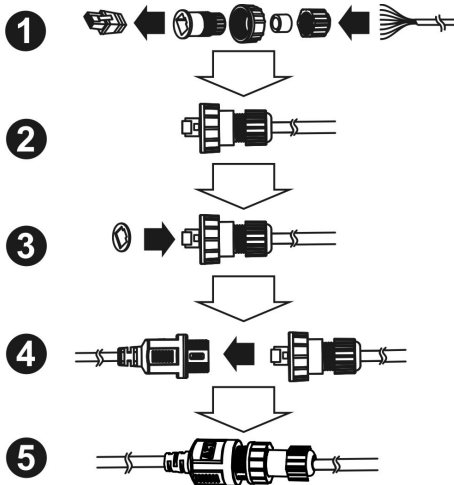

Step 3. Install Camera and Network Devices

The Outdoor Bullet camera can either be connected to a PoE-enabled switch or a non-PoE switch.

I. If using a PoE-enabled switch:

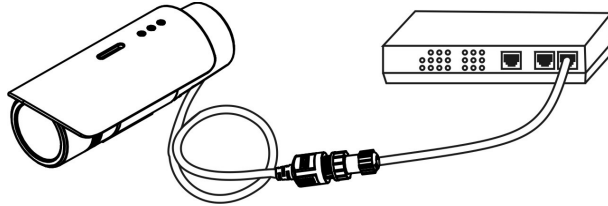

- 1) Use a single Ethernet cable to connect the camera to the PoE-enabled switch.

II. If using a non-PoE switch:

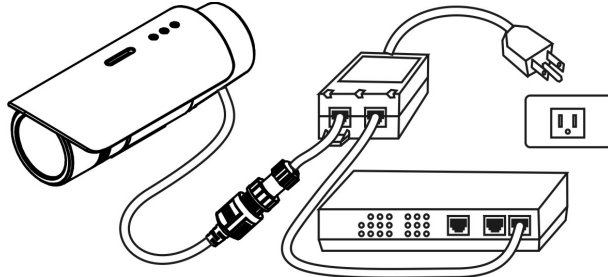

- 1) Use a standard RJ-45 cable to connect the camera to a PoE Injector.
- 2) Use a standard RJ-45 cable to connect the PoE Injector to the non-PoE switch.

III. Use a standard power cable to connect the PoE Injector to a power outlet. If using a PoE injector as power input (For GOB-100A, WOB-100A):

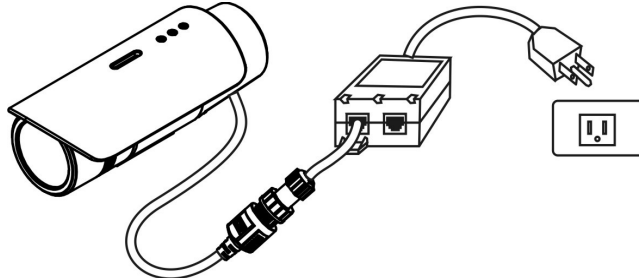

- 1) Use a standard RJ-45 cable to connect the camera to a PoE Injector.
- 2) Use a standard power cable to connect the PoE Injector to a power outlet.

Step 4. Install the EasyConfig Software

Insert the CD into the CD-ROM, and follow the instructions of the InstallShield Wizard to finish installation.



Step 5. Launch EasyConfig

Launch the EasyConfig software, and click on the camera from the survey list to connect.

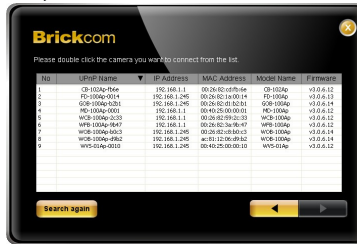

Follow the EasyConfig software to configure the camera's IP address and EasyLink™ settings.



Step 6. Installation Completed

Click <Live View> to view the live video feed of the network camera.

